















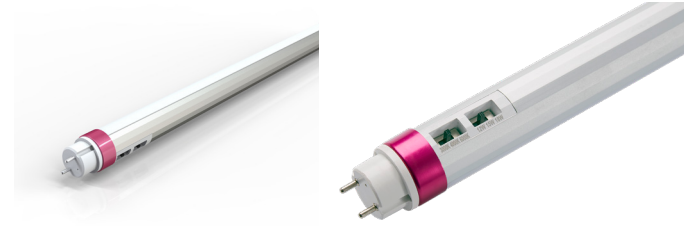
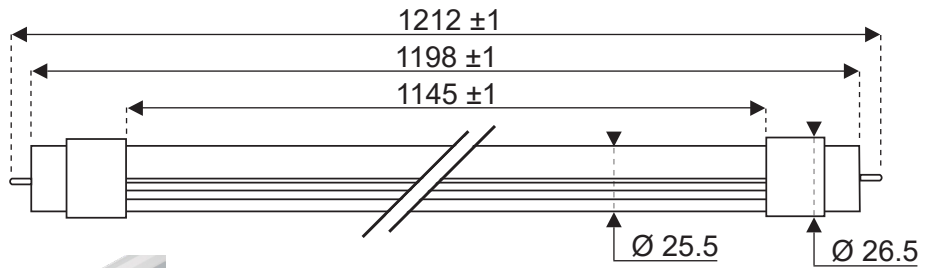





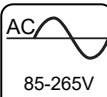

# LED120RLCCT

-  LED-T8 Röhrenlampe für KVG, VVG
-  LED-T8 Tube for conventional ballast
-  Tubo LED-T8 per alimentatore convenzionale
-  LED-T8 buis voor conventionele ballast
-  Tube LED-T8 pour ballast conventionnel
-  Tubo LED-T8 para balasto convencional





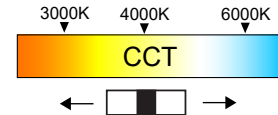

## Technische Spezifikationen Technical specifications Specifiche tecniche Technische specificaties Spécifications techniques Especificaciones técnicas

<b>LED</b> P <sub>ON</sub> 18W 2700Lm 3000/4000/6000K SMD2835 150Lm/W bei 4000K	 50.000h	 IP20	 >25.000	 CRI>80	 Spektrum A-G
 120-300V	 85-265V PF> 0.9		 < 0,5 sec	 max 40°C min -20°C	 120°
					 SDCM<4
					 24h

## Einstellungen Verbrauch und Lichtfarbe Settings consumption and light color Impostazioni di consumo e colore della luce Instellingen voor verbruik en lichtkleur Réglages de la consommation et de la couleur de la lumière Ajustes de consumo y color de la luz

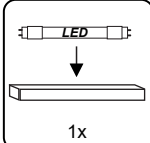

## Spezifikationen Versand Specifications Shipping Specifiche Spedizione Specificaties Verzending Spécifications Livraison Especificaciones de envío

 1x	 1250 x 200 x 210mm 25x	Zolltarifnummer Customs tariff number numero della tariffa doganale douanetaarifnummer numéro de tarif douanier Número del arancel aduanero 85395200000	 250g Netto	 448g Brutto
--	---	---	---	--

### DE - Sicherheits- und Entsorgungshinweise

- Lampeninstallation nur bei unterbrochener Stromversorgung vornehmen.
- Beschädigte Lampen nicht verwenden.
- Die Installation darf nur durch eine Elektrofachkraft durchgeführt werden.
- Der Leistungs- und Farbschalter dürfen während des Betriebes nicht betätigt werden.
- LED-Lampen nur gemäß des Lampenherstellers einsetzen und betreiben. Zulässige Spannung und Leistungsangabe des Leuchtmittels unbedingt beachten. Über- bzw. Unterschreitung können die LED-Leuchte beschädigen.
- Der Betrieb mit Starterlampen wie z.B. Leuchtstofflampen/Röhren im gleichen Schaltkreislauf ist nicht gestattet.
- Der Dauerbetrieb mit belüfteten Leuchtgehäusen ist zulässig.
- Für den Betrieb mit elektronischen Steuerungen sollte unbedingt eine Elektrofachkraft hinzugezogen werden.
- Defekte Leuchten nicht über den Hausmüll entsorgen.
- Rücknahme über die öffentlichen Sammelstellen.

### NL - Veiligheids- en verwijderingsaanwijzingen

- Voer de installatie van de lamp alleen uit als de stroomvoorziening is onderbroken.
- Geen beschadigde lampen gebruiken.
- De installatie mag alleen worden uitgevoerd door een gekwalificeerde electricien.
- De aan/uit-schakelaar en de kleurenschakelaar mogen tijdens het gebruik niet worden bediend.
- Gebruik en gebruik LED lampen alleen volgens de aanwijzingen van de fabrikant. Altijd de toegestane spanning en het vermogen van de lamp in acht nemen. Overschrijding of onderschrijding van deze waarden kan de LED-armatuur beschadigen.
- Gebruik met startlampen zoals fluorescentielampen/buizen in hetzelfde circuit is niet toegestaan.
- Continu gebruik met geventileerde armatuurbehuizingen is toegestaan.
- Voor gebruik met elektronische regelingen moet altijd een gekwalificeerde electricien worden geraadpleegd.
- Gooi defecte armaturen niet bij het huisvuil.
- Breng ze terug via openbare verzamelpunten.

### GB - Safety and disposal instructions

- Only carry out lamp installation when the power supply is interrupted.
- Do not use damaged lamps.
- The installation may only be carried out by a qualified electrician.
- The power switch and color switch must not be operated during operation.
- Use and operate LED lamps only in accordance with the lamp manufacturer's instructions. Always observe the permissible voltage and power rating of the lamp. Exceeding or falling below these values can damage the LED luminaire.
- Operation with starter lamps such as fluorescent lamps/tubes in the same circuit is not permitted.
- Continuous operation with ventilated luminaire housings is permitted.
- For operation with electronic controls, a qualified electrician should always be consulted.
- Do not dispose of defective luminaires in household waste.
- Take them back via public collection points.

### F - Conseils de securite et de recyclage

- Ne procéder à l'installation de la lampe que si l'alimentation électrique est interrompue.
- Ne pas utiliser de lampes endommagées.
- L'installation ne doit être effectuée que par un électricien qualifié.
- Le commutateur de puissance et le commutateur de couleur ne doivent pas être actionnés pendant le fonctionnement.
- Ne mettre en place et ne faire fonctionner les lampes LED que conformément aux instructions du fabricant de la lampe. Respecter impérativement la tension autorisée et l'indication de puissance de la lampe. Les dépassements ou les sous-dépassements peuvent endommager le luminaire à LED.
- Le fonctionnement avec des lampes de démarrage telles que des lampes/tubes fluorescents dans le même circuit est interdit.
- Le fonctionnement continu avec des boîtiers de luminaires ventilés est autorisé.
- Pour le fonctionnement avec des commandes électroniques, il est impératif de faire appel à un électricien spécialisé.
- Ne pas jeter les luminaires défectueux avec les ordures ménagères.
- Récupérer auprès des centres de collecte publics.

### I - Istruzioni di sicurezza e smaltimento

- Eseguire l'installazione della lampada solo quando l'alimentazione è interrotta.
- Non utilizzare lampade danneggiate.
- L'installazione deve essere eseguita esclusivamente da un elettricista qualificato.
- L'interruttore di alimentazione e l'interruttore del colore non devono essere azionati durante il funzionamento.
- Utilizzare e far funzionare le lampade LED solo in conformità alle istruzioni del produttore della lampada. Rispettare sempre la tensione e la potenza ammissibili della lampada. Il superamento o la diminuzione di questi valori può danneggiare l'apparecchio a LED.
- Non è consentito il funzionamento con lampade di avviamento come lampade fluorescenti/tubi nello stesso circuito.
- È consentito il funzionamento continuo con gli alloggiamenti ventilati dell'apparecchio.
- Per il funzionamento con comandi elettronici, è necessario consultare un elettricista qualificato.
- Non smaltire gli apparecchi difettosi tra i rifiuti domestici.
- Riportarli attraverso i centri di raccolta pubblici.

### ES - Instrucciones de seguridad y eliminación

- Realice la instalación de las lámparas únicamente cuando se interrumpa el suministro eléctrico.
- No utilice lámparas dañadas.
- La instalación sólo puede ser realizada por un electricista cualificado.
- El interruptor de encendido y el interruptor de color no deben accionarse durante el funcionamiento.
- Utilice y haga funcionar las lámparas LED únicamente de acuerdo con las instrucciones del fabricante de la lámpara. Respete siempre la tensión y la potencia nominal admisibles de la lámpara. Superar o quedar por debajo de estos valores puede dañar la luminaria LED.
- No está permitido el funcionamiento con lámparas de arranque como lámparas/tubos fluorescentes en el mismo circuito.
- Está permitido el funcionamiento continuo con carcassas de luminarias ventiladas.
- Para el funcionamiento con controles electrónicos, debe consultarse siempre a un electricista cualificado.
- No arroje las luminarias defectuosas a la basura doméstica.
- Retírelas a través de los puntos de recogida públicos.



1  
 a

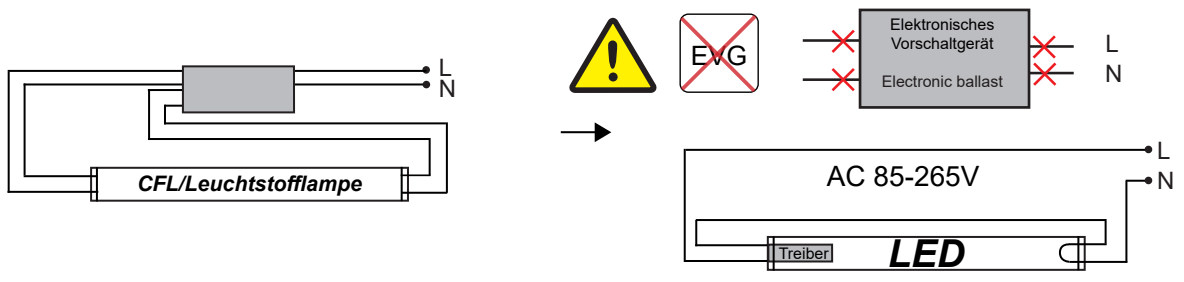
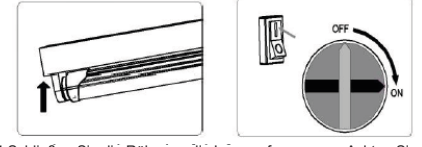
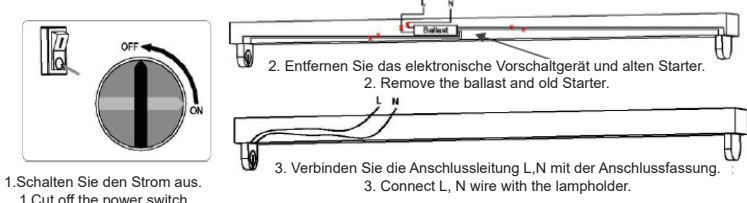

Herkömmliche Kompaktleuchtstofflampen dürfen anschließend **nicht** mehr verwendet werden! Kennzeichnen Sie die Leuchte entsprechend.  
 Conventional compact fluorescent lamps must **not** be used afterwards! Label the luminaire accordingly.

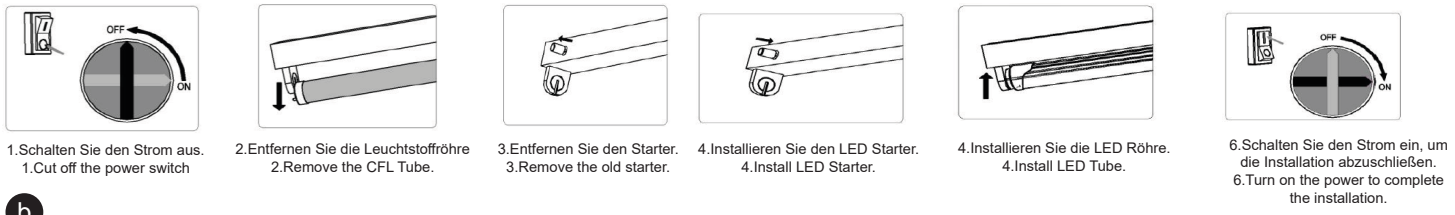

b

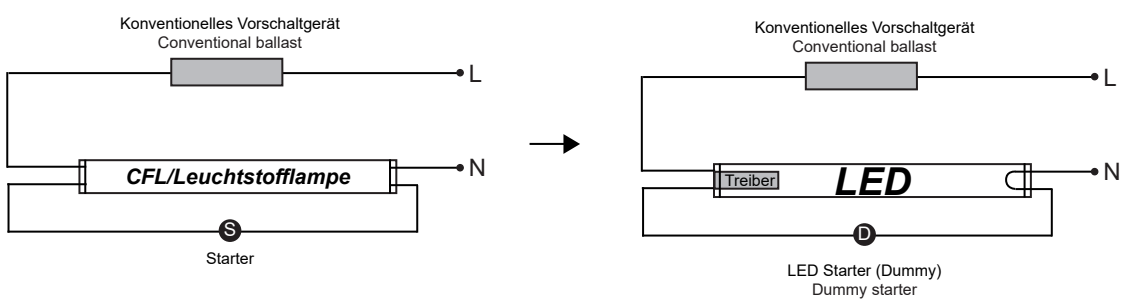

Herkömmliche Kompaktleuchtstofflampen dürfen **nicht** mit diesem Starter verwendet werden! Kennzeichnen Sie die Leuchte entsprechend.  
 Conventional compact fluorescent lamps must **not** be used with this starter afterwards! Label the luminaire accordingly.

c

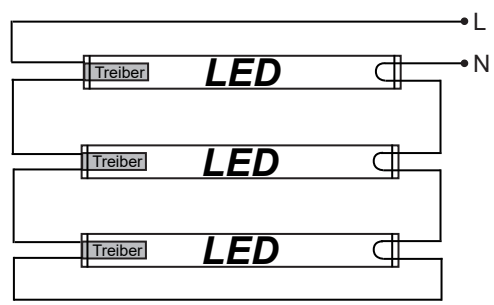

2 Anbringen der neuen Herstellerkennzeichnung mit CE Erklärung an den umgebauten Leuchten.  
 Applying of the new manufacturer's marking with CE declaration to the converted luminaire.

**Achtung LED Konversionsprodukt!**  
 Herkömmliche Kompaktleuchtstofflampen dürfen **nicht** mehr installiert werden!  
 Lampenhersteller:  
 David Communication e.K.  
 Gewerbestraße 10  
 21391 Reppenstedt